

RESOLUTION NO.: 2020-R15
SPONSOR: MAYOR NEUGEBAUER
INTRODUCED: FEB 11, 2020 **ASSIGNED TO:** TCS

A RESOLUTION AUTHORIZING THE PURCHASE OF ONE (1) 2019 KUBOTA M5-111HDC 12 TRACTOR FROM AKRON TRACTOR & EQUIPMENT FOR USE BY THE CITY'S SERVICE DEPARTMENT, AND DECLARING AN EMERGENCY.

WHEREAS, it has been determined that the City is in need of a mowing tractor (boom mower) to perform various tasks within the Service Divisions; and

WHEREAS, the City authorizes the purchase of one (1) 2019 Kubota M5-111HDC 12 Tractor from Akron Tractor and Equipment as through the Sourcewell/NJPA Cooperative Purchasing Agreement waiving competitive bidding.

NOW, THEREFORE, BE IT RESOLVED BY THE COUNCIL OF THE CITY OF GREEN, COUNTY OF SUMMIT, AND STATE OF OHIO THAT:

SECTION ONE:

The Mayor is hereby authorized and directed to enter into a Purchase Agreement with Akron Tractor & Equipment, Akron, Ohio, as the authorized dealer for Northeast Ohio, in an amount not to exceed One Hundred Fifteen Thousand Nine Hundred Fifty-Two Dollars (\$115,952.00). The price quote includes a trade-in of one (1) used Ford 7740 Tractor with the value of Twelve Thousand Dollars (\$12,000.00). Therefore, the total purchase agreement is authorized for a total not to exceed One Hundred Three Thousand Nine Hundred Fifty-Two Dollars (\$103,952.00), as is more fully set forth in the quotation attached hereto and incorporated herein as Exhibit "A".

SECTION TWO:

The requirement for competitive bidding is waived pursuant to Section 210.05 of the Codified Ordinances of the City of Green. This purchase is being made in accordance with the Source Well/NJPA pricing cooperative agreement #052417-AGI, a State of Ohio authorized Purchase Program, in which the City of Green is in good standing.

SECTION THREE:

Green City Council authorizes the Finance Director to make payments to Akron Tractor & Equipment through the established purchase order procedure.

SECTION FOUR:

The City of Green finds and determines that all formal actions of this Council concerning and relating to the adoption of this Resolution were taken in open meetings of this Council and any deliberations of this Council and any of its committees that resulted in those formal actions were in meetings open to the public, in compliance with all legal requirements.

SECTION FIVE:

Green City Council declares this to be an emergency immediately necessary for the preservation of the public peace, health, safety and welfare of the citizens of Green and for the further reason that the need for this equipment is immediate. Provided that this legislation receives the affirmative vote of three-fourths ($\frac{3}{4}$ ths) of the members elected or appointed to Council, it shall take effect and be in force

Page 2
Resolution 2020-R15

immediately upon its passage and approval by the Mayor; otherwise, it shall take effect and be in force at the earliest time allowed by law.

ADOPTED: FEBRUARY 25, 2020
Molly Kapeluck
Molly Kapeluck, Clerk

Barb Babbitt
Barb Babbitt, Council President

APPROVED: Feb. 26, 2020
Gerard M. Neugebauer
Gerard M. Neugebauer, Mayor

COPIED
MAY FIN LAW PLAN ENG
SVCE FIRE PARK ZONE HR

ENACTED EFFECTIVE: February 26, 2020

ON ROLL CALL: Babbitt -aye Brandenburg aye DeVitis aye France aye
Shaughnessy -aye Yeargin aye Young aye adopted 7-0

Suburbanite publication on March 6 and March 13, 2020
Molly Kapeluck
Molly Kapeluck, Clerk

02/06/2020 Approved as to form and content by Lisa Carey Dean, Director of Law [Signature]

AKRON TRACTOR & EQUIPMENT, INC.

1309 Collier Rd, Akron, Ohio 44320

Telephone: 800-821-2785 or 330-836-0237

Cell: 440-773-5800 Email: craig@akrontractor.com

January 16, 2020

City of Green
5383 Massillon Road
Green, Ohio 44232

Our quote is on the Kubota and Terrain King Sourcewell/NJPA Contract Number 052417-AGI, which was renewed on November 1, 2019, your member number is 43737.

One Kubota M5-111HDC12 Tractor with 105.6 Engine Gross Horsepower, 100 Engine Net Horsepower, 4-Cylinder Turbocharged T4F, Cold Start, Cab with AC, 4WD, 12 Forward X 12 Reverse High/Low Shift on the go fully synchronized Transmission, 12.4RX24 R1 Titan Hi Trac Lug WAF Front Tires, 18.4RX30 R1W Titan Hi Power Lug Radial Rear Tires with Cast Rear Wheels, 2 Rear Remote Valves, Rear Window Wiper Kit, Air Ride Seat Suspension Kit, Interior Rearview Mirror, 540E PTO, Radio, Block Heater, Strobe Light Kit, and the Standard Equipment listed on the attached sheet.

Current Kubota Sourcewell/NJPA List Price	\$66,688.00
15% Sourcewell/NJPA Kubota Contract Discount	-\$10,004.00
Subtotal	\$56,684.00
Sourcewell/NJPA Kubota Freight, Prep, and Delivery	\$2,388.00
TOTAL SOURCEWELL/NJPA KUBOTA PRICE	\$59,072.00

One Terrain King Model KB21 Articulated Reach Arm 21' Boom Mower with all the Standard Equipment listed on the attached sheet, Self-Contained Hydraulic System, Joystick Controls, 120 Degree Horizontal Boom Swing, Boom Reach-Up 18' 1.5", Out-21' 7.5", Down-132' 6", Mount Kit for a Kubota M5-111 Tractor, Wheel Weight, Polycarbonate Window, 60" Rotary Mower Head with Hydraulic Center Door, Three Leaf Blade Bar, and Head Swivel, Left Rear Tire Filled with Washer Fluid.

Current Terrain King Sourcewell/NJPA List Price	\$64,636.00
15% Sourcewell/NJPA Terrain King Contract Discount	-\$9,696.00
Subtotal	\$54,940.00
Sourcewell/NJPA Terrain King Freight	\$1,940.00
TOTAL SOURCEWELL/NJPA TERRAIN KING PRICE	\$56,880.00
TOTAL SOURCEWELL KUBOTA & TERRAIN KING PRICE	\$115,952.00

Trade-In: One Used Ford 7740 Tractor, 2WD, 2-Post ROPS & Canopy, Serial 051843B, with 2,800 Hours, Alamo Versa Boom Mower with 60" Rotary Mower Head

	-\$12,000.00
TOTAL SOURCEWELL PRICE LESS TRADE-IN	\$103,952.00

Delivery: 45 to 60 Days

Akron Tractor & Equipment, Inc.

Craig Gorsuch, Sales



KUBOTA

M5 SERIES

M5-091/M5-111

*** EQUIPMENT IN STANDARD MACHINE & SPECIFICATIONS ***

DIESEL ENGINE

Kubota V3800 Direct Injection
3.8L (230 cu. in.) 4 Cyl
EPA Tier 4 Final Compliant
Common Rail Electronic Fuel Injection
Electronic Engine Management
Turbocharged
w/Wastegate and Intercooled
60 Amp Alternator - ROPS
80 Amp Alternator - Cab
12V 900 CCA Battery

EXHAUST EMISSION CONTROL TYPE

DPF System (Diesel Particulate Filter)
SCR System

HYDRAULICS / HITCH / DRAWBAR

Open Center Gear Pump
Max. Flow @ Rated Engine Speed
ROPS: 2400 rpm
Cab: 2600 rpm
Power Steering: 5.4 gpm
Impl. Flow - ROPS: 15.9 gpm
Impl. Flow - Cab: 17.0 gpm
total Flow - ROPS: 21.3 gpm
Total Flow - Cab: 23.1 gpm

REMOTE VALVES

(1) SCD (Self Canceling Detent)
(1) FD (Float Detent) on -1 models (2 Total standard)

3 Point Hitch & Drawbar

Cat II 3-Point Hitch
8 Speed Models
@ Lift Points: 7055 lbs
(ASAE)@ 24" Behind: 5181 lbs
12/24 Speed Models
@ Lift Points: 8600 lbs
(ASAE)@ 24" Behind: 7275 lbs
2 External Lift Cylinders
Telescoping Lower Links
Stabilizers
Swinging Drawbar - Straight

POWER TAKE OFF

Live-Independent Hyd. PTO
SAE 1 3/8" Six Spline
540 RPM @ 2205 Eng. RPM
540 RPM @ 2035 Eng. RPM - 12/24 speed
540E* @ 1519 Eng. RPM

Transmission/PTO

8F/8R Two Range, 4-Speed
12F/12R Two Range, 6-Speed
540/540E
24F/24R Two Range, 6-Speed Hi/Lo
540/540E
24 speed on M5-111 only
Electronic 4WD Function
Electro-Hydraulic Shuttle Shift
Clutch - Multi-Plate Wet
Planetary Final Drives
Hydraulic Wet Disc Brakes

FRONT AXLE

Hydrostatic Power Steering
2WD: Tubular Steel Beam Telescoping
4WD: Cast Iron, Bevel Gear 55 Deg
Planetary Final Drives
Adjustable (Rim) Tread Spacing

FLUID CAPACITY

Fuel Tank Capacity: 27.7 gal
DEF Tank Capacity: 3.2 gal
Cooling System: 11 qts
Crankcase: 11.3 qts
Hydraulics/Trans: 15.85 gal

INSTRUMENTS

LCD readout for MPH and PTO rpm
RPM Memory
Tachometer/Hour meter
Oil Pressure
Fuel Gauge
Coolant Temperature
Gear Speed Digital Light Indicator
Digital Light Indicator F/R Direction

TIRES AND WHEELS

Front 12.4-24
Rear 18.4-30

Ultra Grand Cab II

4-Post, ROPS Certified
RH & LH Doors
Tinted Glass Doors and Windows
In-Roof Window
Tilt Steering Wheel
Dual Level Air Conditioning & Heater
Front and Wiper w/ Washer
Front Sun Visor
Retractable Seat belt
LH & RH Side Mirrors
Radio Ready Cab
Steps, Left and Right Side
Interior Dome Light
12V - 30-Amp 2 Wire Coupler
12V - 3 Pin 30-Amp Coupler
12V - Outlet
Cup Holder
Instructor Seat Ready
Horn

LIGHTING

2 Headlights - Tail lights
4 Hazard Flasher Lights w/ Turn Signals
2 Grill Mounted Worklights
2 Front Cab Halogen Worklights
2 Rear Halogen Worklights

SAFETY EQUIPMENT

Flip-Up PTO Shield
Safety Start Switches
Electric Key Shut Off
Parking Brake
Turn Signals
SMV Sign
7-Pin Electrical Trailer Connector

*if equipped 12/24 Standard

Model Specifications		
M5-091		M5-111
SAE Gross HP:	92.5	SAE Gross HP: 105.6
Engine Net HP:	85.5	Engine Net HP: 100
Max. PTO HP:	76	Max. PTO HP: 89





KB21 Mid-Mount Boom Mowers

STANDARD SPECIFICATIONS

- ◆ Boom Reach: Out- 21'-7.5", Up-18'-1.5", Down 13'-6"
- ◆ 120° Horizontal Boom Swing
- ◆ Available as Cable-operated or Electronic Joystick Control Versions
- ◆ Self contained Hydraulic System (No need to use the tractor remotes)
- ◆ Front Mounted Hydraulic Pump with bottom guard
- ◆ 45 Gallon Under Fender Oil Reservoir
- ◆ Axle-Mounted Boom Rest
- ◆ Mount Kit, all Wheel Weight, and Polycarbonate Window Included in Base Price
- ◆ Tractor Req: Min of 6,800 lbs and 80 HP, Min 85" Wheelbase and 17" Ground Clearance
- ◆ Minimum Operating weight: 6700 lbs.
- ◆ Standard (1) year limited parts and labor warranty.

HEAD SPECIFICATIONS

- ◆ 60" Cutting Diameter
- ◆ Capable of Cutting 5" Grass and Brush Material
- ◆ 14 Gauge Deck Material with Vertical Ribbing for Reinforcement
- ◆ Direct-Coupled Motor
- ◆ 1.25" x 6" Single Leaf Blade Bar,
- ◆ 1/2" x 4" Alloy Steel Updraft Blades, 360° Swing
- ◆ Mechanically Operated Front Access Door
- ◆ Full Length Replaceable Skid Shoes



TERRAINKING™

Engineering Practical Solutions™

sold exclusively
by selected
Kubota dealers

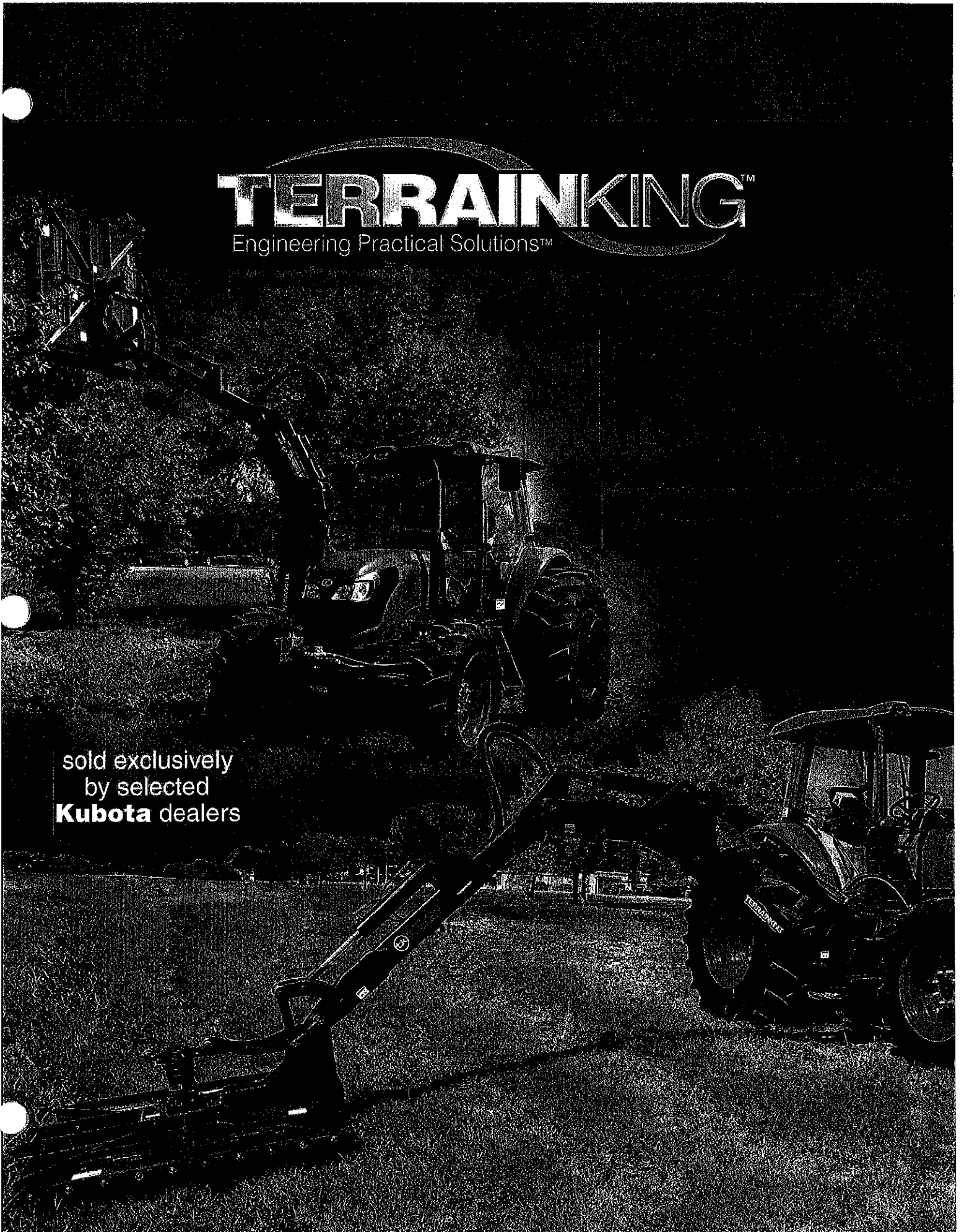

TERRAINKING™

Engineering Practical Solutions™

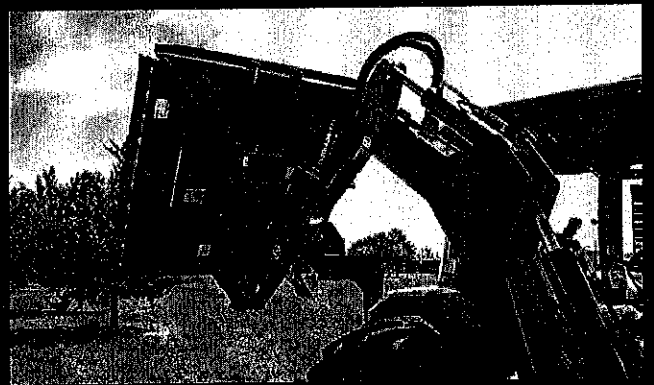
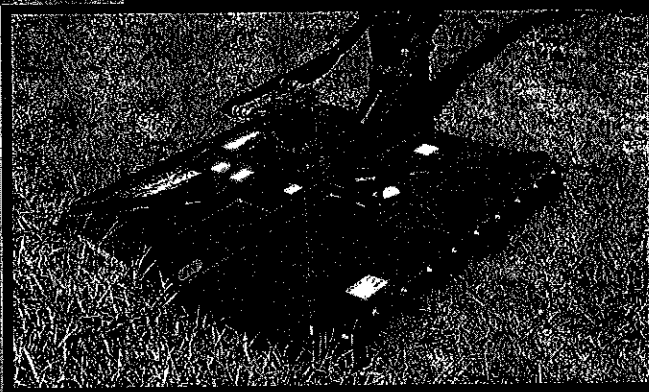
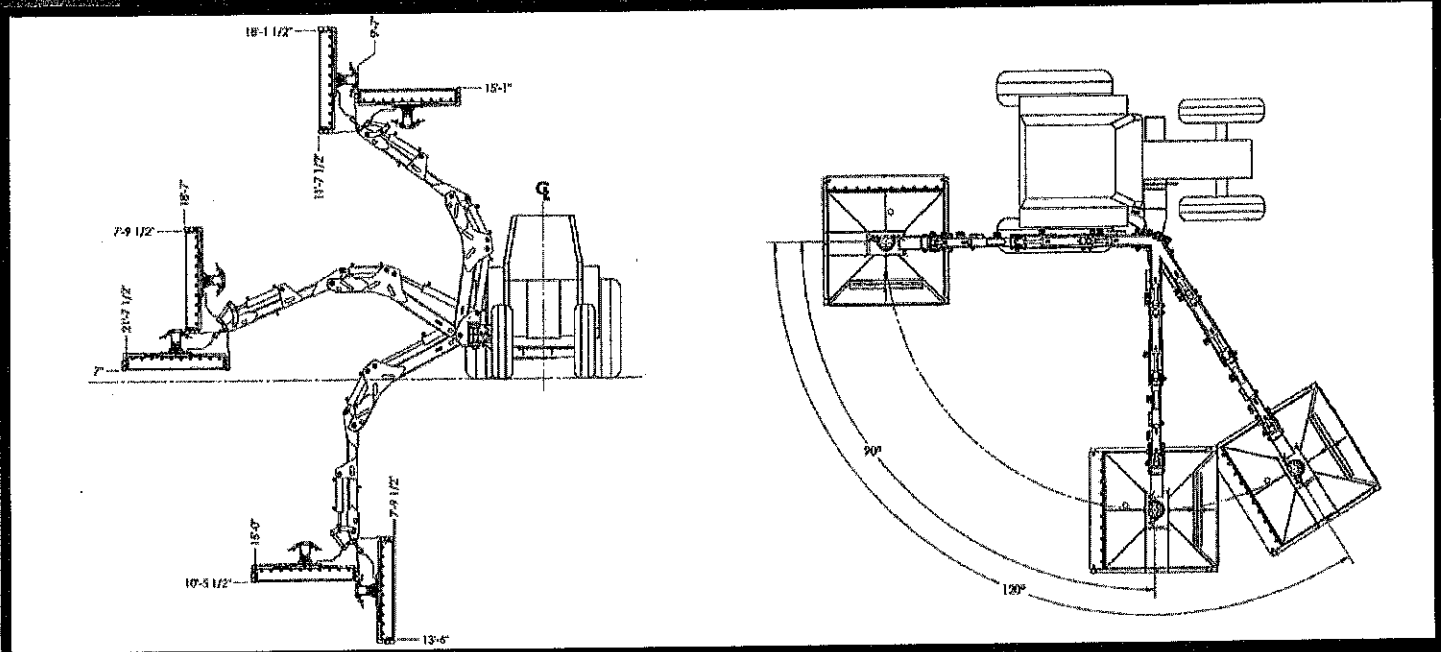



Blade

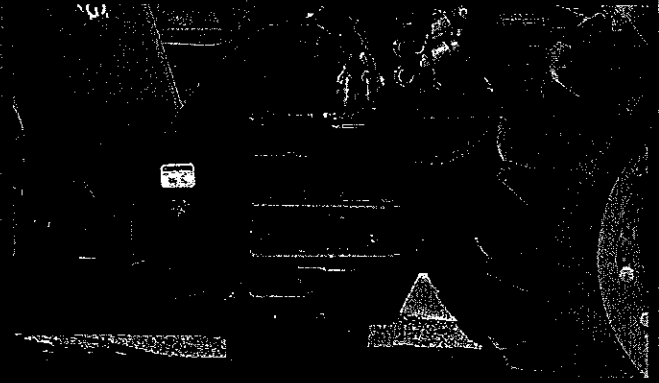

Blade

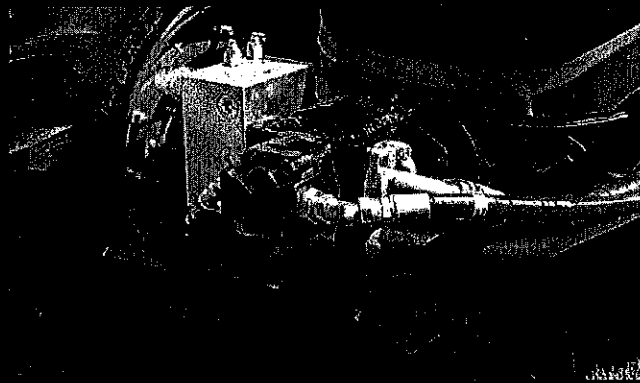

TERRAIN KING™

Engineering Practical Solutions™

the Cutting Edge Safety program

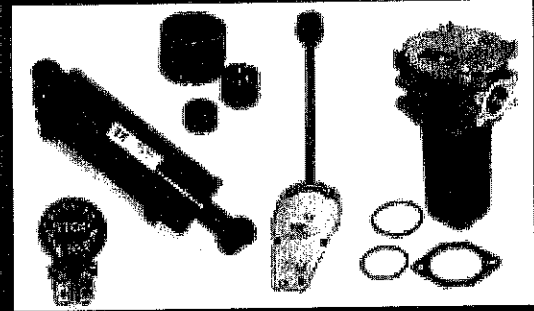

OEM PERFORMANCE PARTS TERRAIN KING

and to assist in finding the parts you need.